

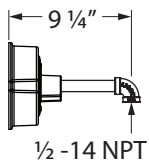

LED GOOSENECK LIGHTING

MKT-0019, REV A

With their iconic style and practical purpose, our selection of LED compatible gooseneck arms contains the ideal option for every space. To properly illuminate interior and exterior settings, a variety of angles and shapes focus light onto sidewalks, tables and more. Every gooseneck arm is constructed in our Florida-based manufacturing facility. Please Note: Select gooseneck arms cannot be used with certain designs and shades. For additional information, please visit the individual product listing. Additionally, gooseneck arms indicated with an asterisk are not available in copper and brass finishes.



G3*

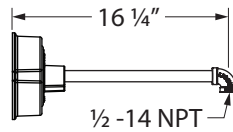

G1*

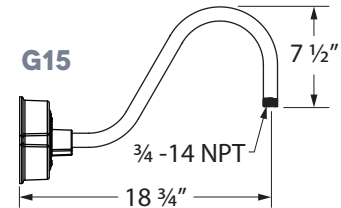

G15

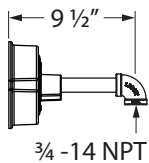

G4

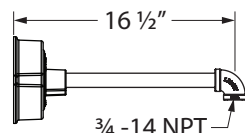

G14

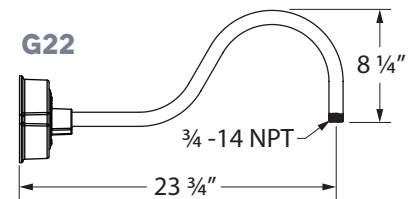

G22

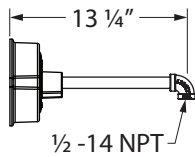

G16*

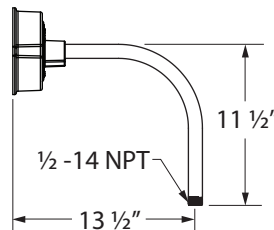

G12*

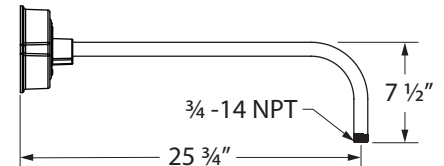

G8

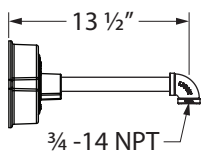

G17

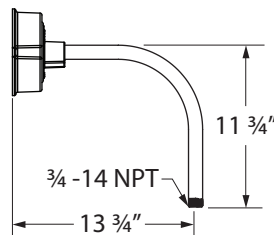

G13

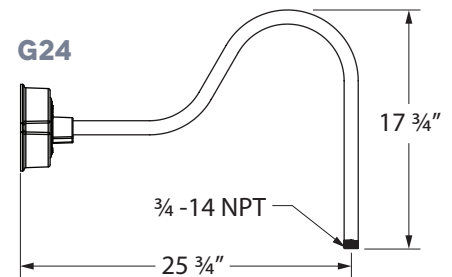

G24

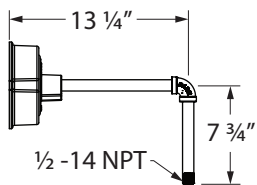

G35*

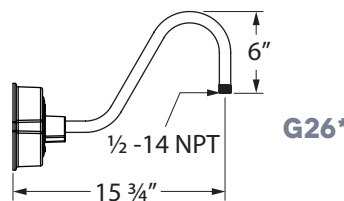

G26*

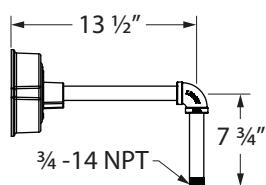

G34*

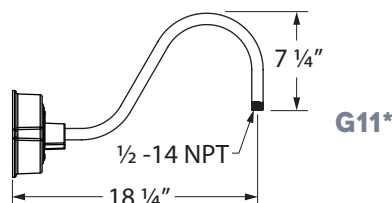

G11*

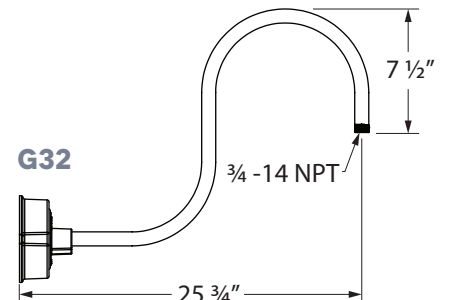

G32

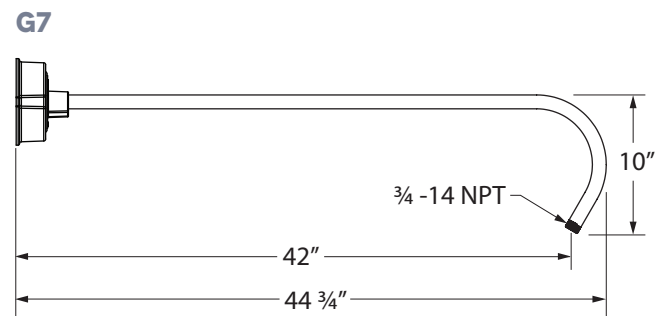
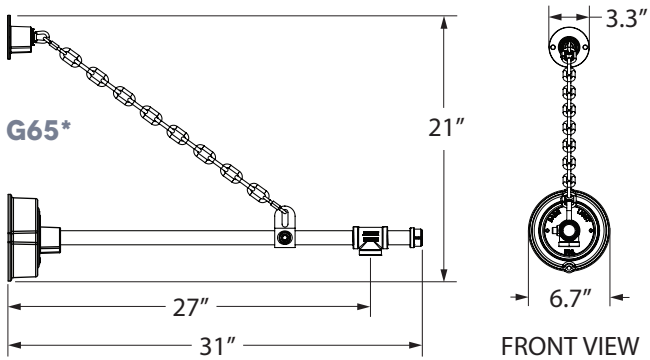
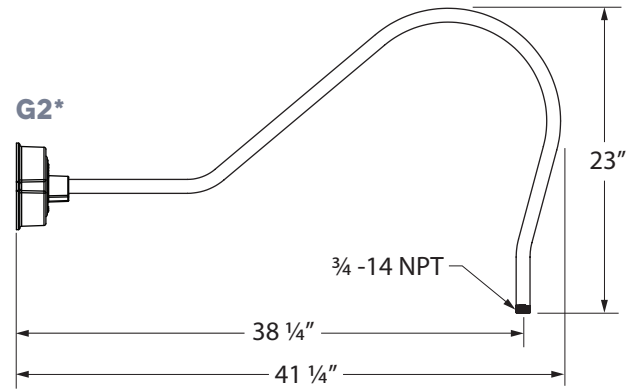
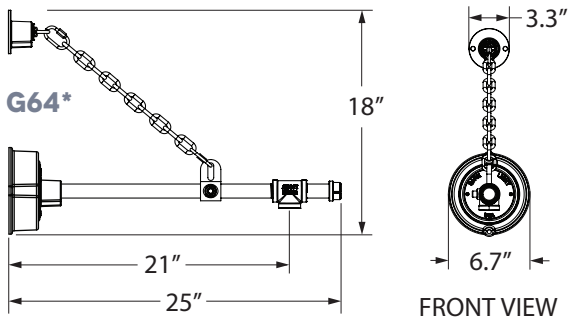
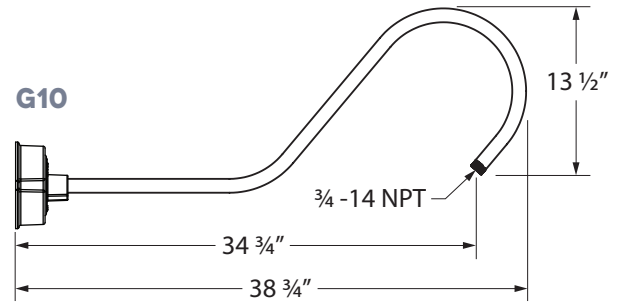
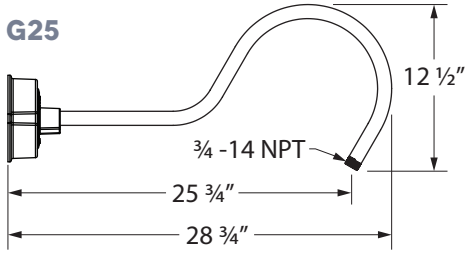
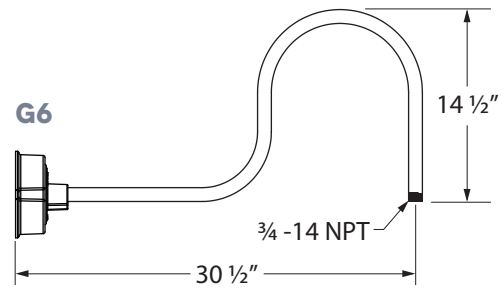
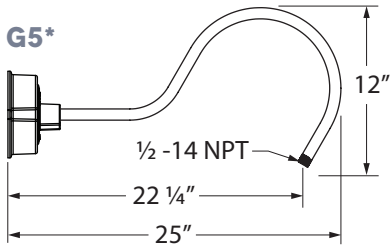

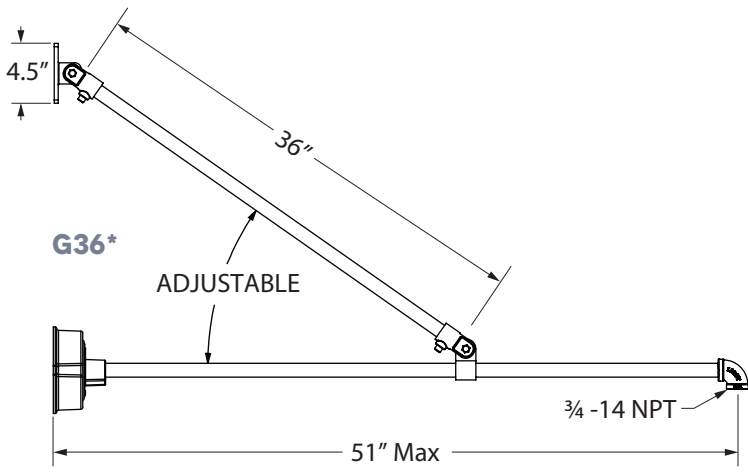

G36*

ADJUSTABLE

3/4 - 14 NPT

51" Max

G9

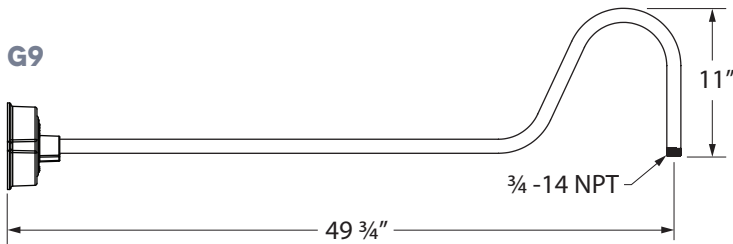

3/4 - 14 NPT

49 3/4"

11"

LED WALL BACKING PLATE DIMENSIONS

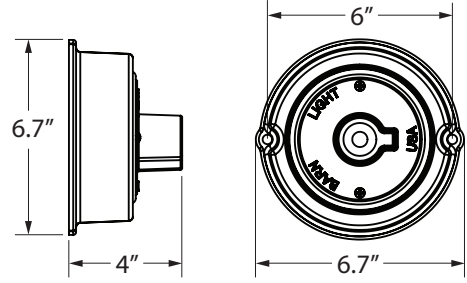

SIDE VIEW

FRONT VIEW

OPTIONAL MOUNTING ACCESSORIES

For a more formal and refined aesthetic, a decorative cover can conceal the gooseneck's backing plate. With an array of powder coat colors, the backing plate takes on various looks, ranging from playful to simple and timeless, while natural copper and brass finishes offer a more sophisticated style.

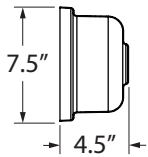

LDBPC
LED Decorative
Backing Plate Cover