



REV 10.03.18

OLD DIXIE/BOMBER SERIES

BARN LIGHT RLM FIXTURE FAMILY

Max Weight: 10.0 lbs

PROJECT NAME _____

PROJECT TYPE _____

SPS-0149

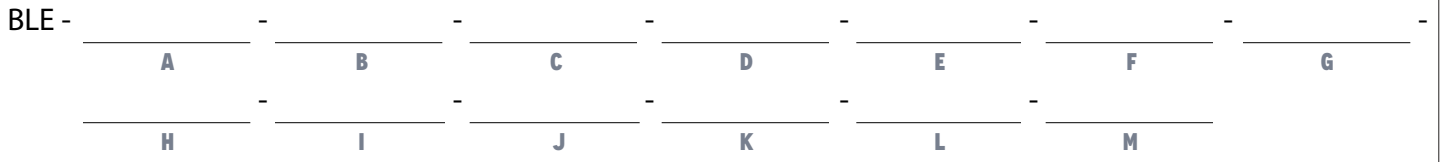

Order Example: BLE - G - WHB15 - 400 - G22 - 975 - NA - CGG - 975 - SMK - HDBP - E26 - NA - NA

A - MOUNTING STYLE

- C Cord Hung
CN Chain Hung
F Flush Mount
G Gooseneck
S Stem Mount

B - SHADE SIZE

- OLD DIXIE/BOMBER:
WHB112
WHB13
WHB15
WHB17

C - SHADE FINISH

- POWDER COAT FINISHES3:
100 Black
105 Textured Black
200 White
300 Dark Green
307 Emerald Green
311 Jadite
370 Mint
380 Chartreuse
390 Teal
400 Barn Red
420 Orange
470 Watermelon
480 Blush Pink
490 Magenta
500 Buttery Yellow
570 Sunflower
600 Bronze
601 Chocolate
605 Rust
615 Oil-Rubbed Bronze
700 Royal Blue
705 Navy
710 Cobalt Blue
715 Delphite Blue
800 Industrial Grey
805 Charcoal Granite
810 Graphite
975 Galvanized

- PORCELAIN FINISHES4:
150 Black
250 White
350 Vintage Green
355 Jadite
455 Cherry Red
550 Yellow
650 Bronze
750 Cobalt Blue

C - SHADE FINISH (CONTINUED)

- PORCELAIN FINISHES4:
765 Delphite Blue
850 Graphite
950 Metallic Chrome
NATURAL FINISHES10:
995 Raw Copper
996 Weathered Copper
997 Raw Brass
998 Weathered Brass
999 Oil-Rubbed Copper

D - MOUNTING

- CSA LISTED CORD OPTIONS:
SBK Standard Black
SWH Standard White
CSB Black Cloth
CSW White Cloth
CSR Red Cloth
CSBB Black & Brown Cloth
CSRW Red & White Cloth
CSGW Gold & White Cloth
CSBG Black & Gold Cloth
CSBW Black & White Cloth
CSBP Black & Pink Cloth
CSUW Blue & White Cloth

- NON-CSA LISTED CORD OPTIONS:
CBK Black Cotton
CMG Grey Cotton
CRZ Red Chevron
TBK Black Cotton Twist5
TWH White Cotton Twist5
TBR Brown Cotton Twist5
TRD Red Cotton Twist5
TPT Putty Cotton Twist5
TBW Black & White Twist5
TRW Red & White Twist5
TBB Brown & Beige Twist5

- CHAIN MOUNT OPTIONS:
CN36 3' of Chain1
CN48 4' of Chain1
CN60 5' of Chain1
CN72 6' of Chain1

- FLUSH MOUNT OPTIONS:
FM1

- GOOSENECK OPTIONS:
G1' G16'
G2' G17
G3' G191.5
G4 G22

D - MOUNTING (CONTINUED)

- GOOSENECK OPTIONS:
G5' G24
G6 G25
G7 G261
G8 G32
G9 G341
G10 G351
G11' G361
G12' G401.5
G13 G641
G14 G651
G15

- STEM MOUNT OPTIONS:
ST506 .5" Stem Mount, 6"1
ST512 .5" Stem Mount, 12"1
ST518 .5" Stem Mount, 18"1
ST524 .5" Stem Mount, 24"1
ST536 .5" Stem Mount, 36"1
ST548 .5" Stem Mount, 48"1
ST706 .75" Stem Mount, 6"
ST712 .75" Stem Mount, 12"
ST718 .75" Stem Mount, 18"
ST724 .75" Stem Mount, 24"
ST736 .75" Stem Mount, 36"
ST748 .75" Stem Mount, 48"

E - MOUNTING FINISH

- Please Note: See Section C for Finish Options. 980-Brushed Aluminum is also available for Gooseneck and Stem mounting styles. If Porcelain Finish is selected, mounting will be powder coat painted-to-match.
(1) If Cord Hung [C] or Flush Mount [F] Mounting Style, selection identifies canopy finish
(II) If Chain Hung [CN] Mounting Style, selection identifies chain and canopy finish
(III) If Stem Mount [S] Mounting Style, selection identifies stem and canopy finish
980 Brushed Aluminum

F - CORDS9

- NA Not Applicable
Please Note: See Section D for all applicable CSA Listed Cord Options. Non-CSA Listed Cord Options for Chain Hung Mounting Style limited to: Black Cotton [CBK], Red Chevron [CRZ] and Grey Cotton [CMG]

G - SHADE ACCESSORIES

- NA None
WC Wire Cage1
TGG Heavy Duty Guard1.6
CGG Cast Guard1.6
WGG Wire Guard1.6

H - SHADE ACCESSORY FINISH

- Please Note: See Section C for Finish Options. Natural Finishes not applicable with Wire Cage or Guard. If Porcelain Finish is selected, accessory will be powder coat painted-to-match
NA Not Applicable

I - GLASS OPTION

- NA Not Applicable
CLR Clear Glass6,11
FST Frosted Glass6
RIB Ribbed Glass6
CCR Clear Crackle Glass6
SMK Smoke Crackle Glass6
HCR Honey Crackle Glass6

J - MOUNTING ACCESSORY

- NA None/Not Applicable
HSC Hang Straight Canopy12,13
HDSMC Heavy Duty Stem Mount Canopy12,5,13
HDBP Heavy Duty Backing Plate15
DD Dusk-to-Dawn Photocell5
DBPC Decorative Backing Plate Cover
LDBPC LED Decorative Backing Plate Cover
DCHX Decorative Backing Plate Cover & Hex Cover
LDCHX LED Decorative Backing Plate Cover & Hex Cover

K - LIGHT SOURCE

- E26 200 Watt Max6
GU24 24 Bi-Pin, 23W Max6
LED11 850 Lumen, 11W LED7
LED16 1250 Lumen, 16W LED7
LED16.8 1600 Lumen, 16W LED6
LED27 2000 Lumen, 27W LED7
LED38 3000 Lumen, 38W LED7
LED43 4000 Lumen, 43W LED7

L - COLOR TEMPERATURE8

- NA Not Applicable
2700K 2700K, Warm White
3000K 3000K, Neutral White
3500K 3500K, Bright White
4000K 4000K, Cool White

M - LED LENS8,12

- NA Not Applicable
DL Domed Lens
FL Flat Lens

IMPORTANT: (1) Not available in Natural Finishes (2) If LED option chosen, only available with LED11 & LED16 (3) All Powder Coat finished shades, Galvanized excluded, feature a white interior (4) All Porcelain Enamel finished shades feature a white interior and a black outer rim (5) Not available in LED (6) Guard and Glass accessory reduces incandescent wattage to 100W Max, GU24 Bi-Pin to 18W Max and LED Max to 1600 Lumens (7) Not available with the Guard & Glass Accessory (8) Only applicable if an LED Light Source is selected in Section K, select NA if another light source is selected (9) Only applicable if Chain Hung Mounting Style selected in Section A, select NA if another Mounting Style is selected (10) Natural Finishes have a longer estimated manufacturing time, please check the website for exact lead time. There are no returns accepted on Natural Finishes (11) Not recommended if LED Light Source is selected in Section K (12) Not applicable if LED16.8 Light Source selected in Section K (13) Only applicable if Stem Mount Mounting Style is selected in Section A

MOUNTING STYLE

Galvanized steel shades are crafted from 20 Ga Sheet metal while 1100-0 Aluminum—ranging from ranging from 0.050" to 0.125"—is used for all other shades. All shades have their edges rolled, and the result is highly durable and stylish lighting.

CHAIN HUNG PENDANT (CN)

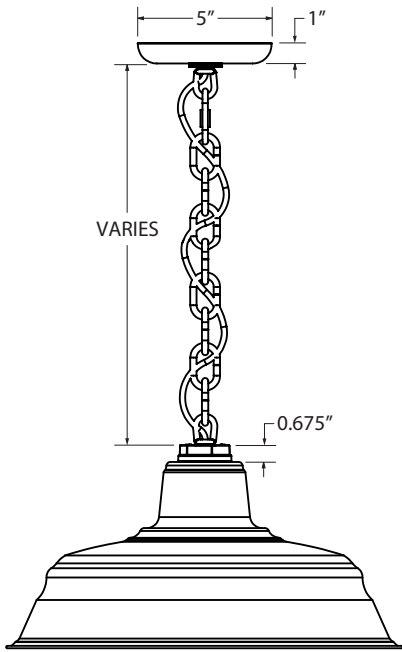

FLUSH MOUNT (F)

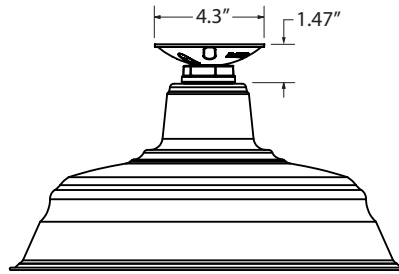

STEM MOUNT PENDANT (S)

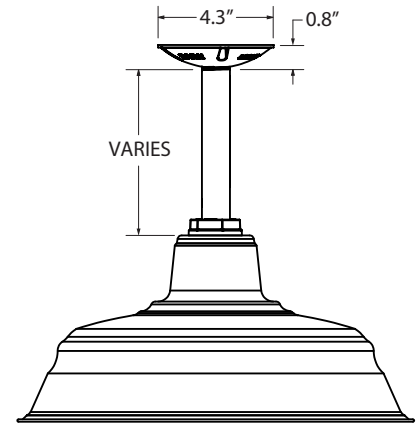

GOOSENECK (G)

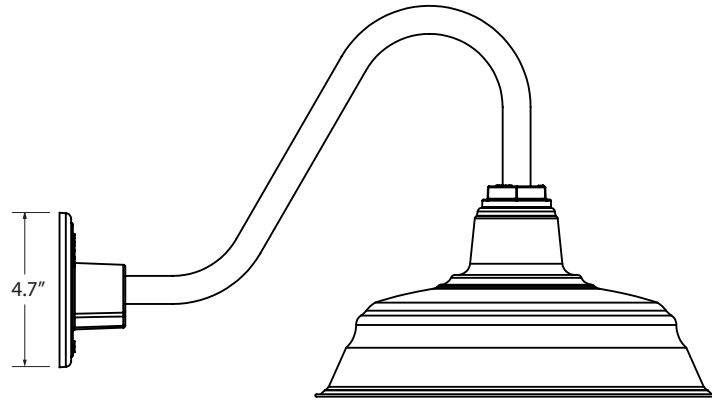

SHOWN WITH: G26 GOOSENECK ARM

CORD HUNG PENDANT (C)

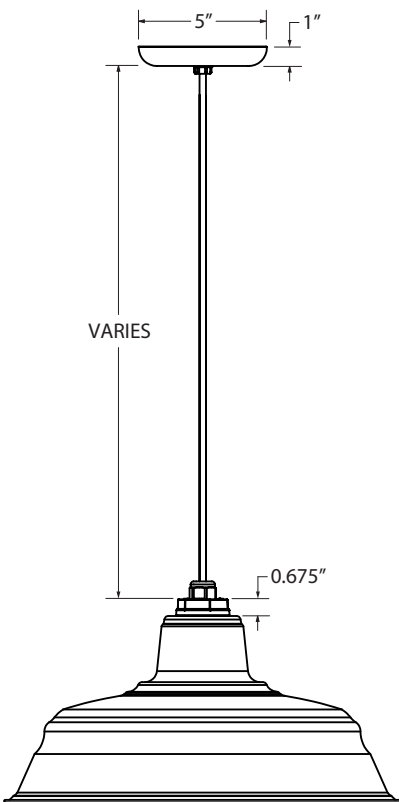

AVAILABLE SHADE SIZES

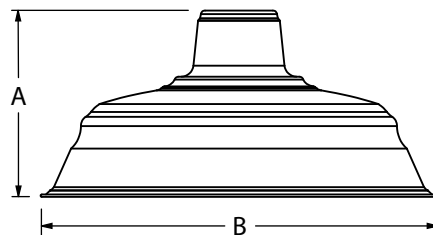

SHADE CODE	HEIGHT (A)	DIAMETER (B)
WHB11	6"	11"
WHB13	6"	13"
WHB15	7"	15"
WHB17	8.25"	17"

LIGHT SOURCE

All published luminaire photometric testing performed to IESNA LM-79-08 standards by a NVLAP accredited laboratory. Data is considered to be representative of the configurations shown, within the tolerances allowed by Lighting Facts. To obtain an IES file specific to your project, please contact the factory.

OPTION	WATTAGE	LUMENS <small>*Avg. value, actual value dependent on bulb used</small>	CRI	VOLTAGE	DIMMING
LEDS					
LED11	11W	850	>90	120 VAC	TRIAC
LED16	16W	1250	>90	120 VAC	TRIAC
LED16.8	16W	1600	>90	120 VAC	TRIAC
LED27	27W	2000	>90	120-277 VAC	0-10V
LED38	38W	3000	>90	120-277 VAC	0-10V
LED43	43W	4000	>90	120-277 VAC	0-10V
INCANDESCENT (MED E26)					
E26	200W Max	*3000	*100	120 VAC	Bulb Dependant
COMPACT FLOURESCENT (GU24 CFL)					
GU24	23W Max	*1600	*75	120 VAC	Bulb Dependant

SPECIFICATIONS

MOUNTING

STEM

1/2" Nominal (0.84" Actual) or 3/4" Nominal (1.05" Actual) Sch 40, 6063 Aluminum Mounting Stem. Custom Lengths Available upon Request.

GOOSENECK

1/2" Nominal (0.84" Actual) or 3/4" Nominal (1.05" Actual) Sch 40, 6063 Aluminum Gooseneck

CORD

Cord-hung Pendants Include 7' Of Standard Cord Or 5' Of Cotton Cord, +/- For Socket Orientation

SHADE & FINISHES

OLD DIXIE SHADE

Hand-Spun from High Purity 0.050" Thick 3003-O Temper Aluminum

BOMBER PORCELAIN SHADE

Hand-Spun from 20 Guage Sheet Metal

POWDER COAT FINISHES

Polyester Powder Coat Finishes Are Electro-Statically Applied and Thermocured

PORCELAIN FINISHES

Applied by Hand and Fired in a High Temperature Oven

LED SPECIFICATIONS

LUMEN MAINTENANCE

L90(6K) > 36,300 Hours, LED16.8 Source is L90(11K) > 61,000 Hours.

COLOR TEMPERATURES

Standard Color Temperatures Available Include 2700K, 3000K, 3500K and 4000K. Custom Temperatures Available upon Request.

CRI

Minimum 90 CRI. Consult Factory for Other CRI Options.

EFFICACY

Up to 100 LPW Based on Wattage/Lumens in the Table

DRIVER & DIMMING OPTION

850 and 1250 Lumen, Relient on Triac Dimming 12W / 120V Mounted in Canopy, up to 5% Dimming.
2000, 3000 & 4000 Lumen Reliant on 0-10V Dimmer, Generally up to 10% Dimming.
Requires Compatible Dimming Switch.

CERTIFICATIONS, LISTINGS & WARRANTY

MADE IN THE USA

Manufactured and Hand-Crafted in Our 60,000 Square Foot Facility Located in Titusville, FL

CSA LISTED FOR WET LOCATIONS

Includes All Stem and Gooseneck Mounting Styles

CSA LISTED FOR DAMP LOCATIONS

Includes All Chain and Select Cord Hung Mounting Styles

LIMITED WARRANTY

For Additional Information on Our Limited Warranty, Please See Our Terms & Conditions