

Order Example: BLE - G - ULS16 - 975 - G22 - 975 - NA - CAP - 400 - FST - DD - LED16.8 - 2700K

**A - MOUNTING STYLE**

- C** Cord Hung
- CN** Chain Hung
- F** Flush Mount
- G** Gooseneck
- S** Stem Mount

**B - SHADE & SHADE SIZE**

- THE SYDNEY:*
- ULS12** 12" Shade
  - ULS14** 14" Shade
  - ULS16** 16" Shade
  - ULS18** 18" Shade

**C - SHADE FINISH**

- POWDER COAT FINISHES<sup>2</sup>:*
- 100** Black
  - 105** Textured Black
  - 200** White
  - 300** Dark Green
  - 307** Emerald Green
  - 311** Jadite
  - 370** Mint
  - 380** Chartreuse
  - 390** Teal
  - 400** Barn Red
  - 420** Orange
  - 470** Watermelon
  - 480** Blush Pink
  - 490** Magenta
  - 500** Buttery Yellow
  - 570** Sunflower
  - 600** Bronze
  - 601** Chocolate
  - 605** Rust
  - 615** Oil-Rubbed Bronze
  - 700** Royal Blue
  - 705** Navy
  - 710** Cobalt Blue
  - 715** Delphite Blue
  - 800** Industrial Grey
  - 805** Charcoal Granite
  - 810** Graphite
  - 975** Galvanized
- NATURAL FINISHES<sup>2</sup>:*
- 995** Raw Copper
  - 996** Weathered Copper
  - 997** Raw Brass
  - 998** Weathered Brass
  - 999** Oil-Rubbed Copper

**D - MOUNTING**

- CSA LISTED CORD OPTIONS:*
- SBK** Standard Black
  - SWH** Standard White
  - CSB** Black Cloth
  - CSW** White Cloth
  - CSR** Red Cloth
  - CSBB** Black & Brown Cloth
  - CSRW** Red & White Cloth
  - CSGW** Gold & White Cloth
  - CSBG** Black & Gold Cloth
  - CSBW** Black & White Cloth
  - CSBP** Black & Pink Cloth
  - CSUW** Blue & White Cloth

*NON-CSA LISTED CORD OPTIONS:*

- CBK** Black Cotton
- CMG** Grey Cotton
- CRZ** Red Chevron
- TBK** Black Cotton Twist<sup>3</sup>
- TWH** White Cotton Twist<sup>3</sup>
- TBR** Brown Cotton Twist<sup>3</sup>
- TRD** Red Cotton Twist<sup>3</sup>
- TPT** Putty Cotton Twist<sup>3</sup>
- TBW** Black & White Twist<sup>3</sup>
- TRW** Red & White Twist<sup>3</sup>
- TBB** Brown & Beige Twist<sup>3</sup>

*CHAIN MOUNT OPTIONS:*

- CN36** 3' of Chain<sup>4</sup>
- CN48** 4' of Chain<sup>4</sup>
- CN60** 5' of Chain<sup>4</sup>
- CN72** 6' of Chain<sup>4</sup>

*FLUSH MOUNT OPTIONS:*

- FM<sup>4</sup>**

*GOOSENECK OPTIONS:*

- G1<sup>4</sup>**                      **G16<sup>4</sup>**
- G2<sup>4</sup>**                      **G17**
- G3<sup>4</sup>**                      **G19<sup>4</sup>**
- G4**                        **G22**
- G5<sup>4</sup>**                      **G24**
- G6<sup>4</sup>**                      **G25**
- G7**                        **G26<sup>4</sup>**
- G8**                        **G32**
- G9**                        **G34<sup>4</sup>**
- G10**                      **G35<sup>4</sup>**
- G11<sup>4</sup>**                      **G36<sup>4</sup>**
- G12<sup>4</sup>**                      **G40<sup>4</sup>**
- G13**                      **G64<sup>4</sup>**
- G14**                      **G65<sup>4</sup>**
- G15**

**D - MOUNTING (CONTINUED)**

- STEM MOUNT OPTIONS:*
- ST506** .5" Stem Mount, 6"<sup>1</sup>
  - ST512** .5" Stem Mount, 12"<sup>1</sup>
  - ST518** .5" Stem Mount, 18"<sup>1</sup>
  - ST524** .5" Stem Mount, 24"<sup>1</sup>
  - ST536** .5" Stem Mount, 36"<sup>1</sup>
  - ST548** .5" Stem Mount, 48"<sup>1</sup>
  - ST706** .75" Stem Mount, 6"
  - ST712** .75" Stem Mount, 12"
  - ST718** .75" Stem Mount, 18"
  - ST724** .75" Stem Mount, 24"
  - ST736** .75" Stem Mount, 36"
  - ST748** .75" Stem Mount, 48"

**E - MOUNTING FINISH**

- Please Note: See Section C for all applicable Mounting Finish Options*
- (I) If Cord Hung [C] Mounting Style, selection identifies canopy finish
  - (II) If Flush Mount [F] Mounting Style, select NA
  - (III) If Stem Mount [S] Mounting Style, selection identifies stem and canopy finish
  - (IV) If Chain Hung [CN] Mounting Style, selection identifies chain and canopy finish. Natural finishes not available.
  - (V) If Gooseneck [G] Mounting Style, selection identifies gooseneck and wall backing plate finish
- NA** Not Applicable

**F - CORDS<sup>5</sup>**

- Please Note: See Section D for all applicable CSA Listed Cord Options. Non-CSA Listed Cord Options for Chain Hung Mounting Style limited to: Black Cotton [CBK], Red Chevron [CRZ] and Grey Cotton [CMG]*
- NA** Not Applicable

**G - CAP OPTION<sup>6</sup>**

- NA** No Cap/Not Applicable
- CAP** Cap<sup>6,7</sup>

**H - CAST GUARD FINISH**

*Please Note: See Section C for all applicable Cast Guard Finish Options*  
 (I) Cast Gaurd not available in Natural Finishes

**I - GLASS OPTION**

- CLR** Clear Glass<sup>8</sup>
- FST** Frosted Glass
- RIB** Ribbed Glass
- CCR** Clear Crackle Glass
- SMK** Smoke Crackle Glass
- HCR** Honey Crackle Glass

**J - MOUNTING ACCESSORY**

- NA** None/Not Applicable
- HSC** Hang Straight Canopy<sup>4,9</sup>
- HDSMC** Heavy Duty Stem Mount Canopy<sup>1</sup>
- HDBP** Heavy Duty Backing Plate<sup>4,10</sup>
- DD** Dusk-to-Dawn Photocell<sup>3</sup>
- DBPC** Decorative Backing Plate Cover
- DCHX** Decorative Backing Plate Cover & Hex Cover
- DCC** Decorative Canopy Cover<sup>9,11</sup>

**K - LIGHT SOURCE**

- E26** 100 Watt Max
- GU24** GU24 Bi-Pin, 18W Max<sup>12</sup>
- LED16.8** 16.8W LED, 1600 Lumen

**L - COLOR TEMPERATURE<sup>13</sup>**

- NA** Not Applicable
- 2700K** 2700K, Warm White
- 3000K** 3000K, Neutral White
- 3500K** 3500K, Bright White
- 4000K** 4000K, Cool White

**IMPORTANT:** (1) All Powder Coat finished shades, Galvanized excluded, feature a white interior (2) Natural Finishes have a longer estimated manufacturing time, please check the website for exact lead time. There are no returns accepted on Natural Finishes (3) Not available in LED (4) Not available in Natural Finishes (5) Only applicable if Chain Hung Mounting Style is selected in Section A (6) Cap not available if Chain Hung mounting style is selected in Section A (7) Cap Finish will match shade finish selected in Section C (8) Clear Glass not recommended if LED Light Source is selected in Section K (9) Only applicable if Stem Mounting Style selected in Section A (10) Not available in LED (11) Only available if Natural Finish is selected in Section C (12) Fixtures configured with a GU24 socket are non-returnable (13) Only applicable if LED16.8 Light Source is selected in Section J, select NA is non-LED source selected

**MOUNTING STYLE**

Galvanized steel shades are crafted from 20 Ga Sheet metal while 1100-0 Aluminum—ranging from 0.050" to 0.125"—is used for all other shades. All shades have their edges rolled, and the result is highly durable and stylish lighting.

**CHAIN HUNG PENDANT (CN)**

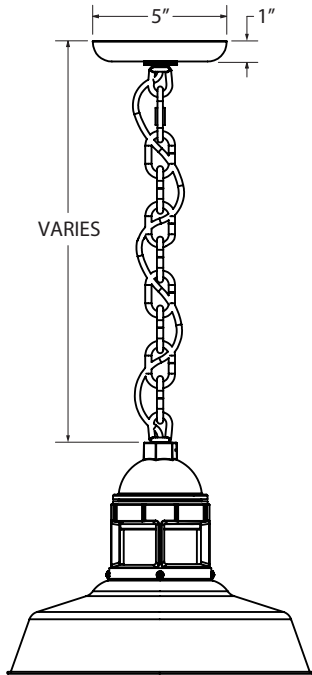

**CORD HUNG PENDANT (C)**

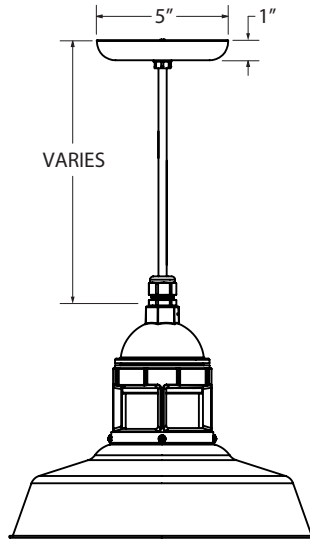

**STEM MOUNT PENDANT (S)**

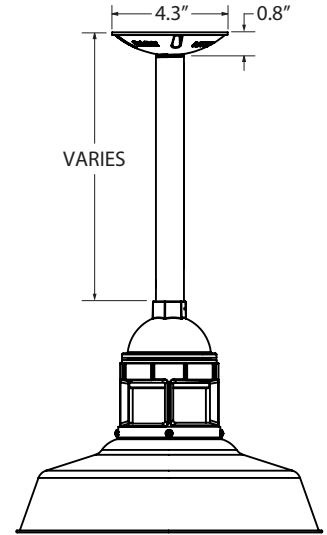

**FLUSH MOUNT (F)**

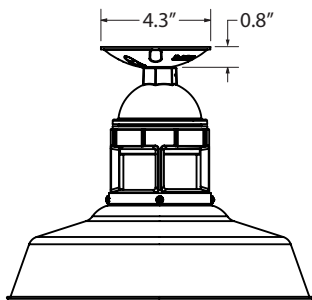

**GOOSENECK (G)**

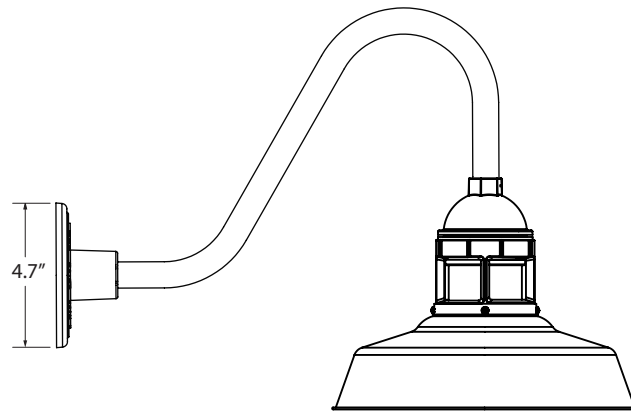

SHOWN WITH: G26 GOOSENECK ARM

**AVAILABLE SHADE SIZES**

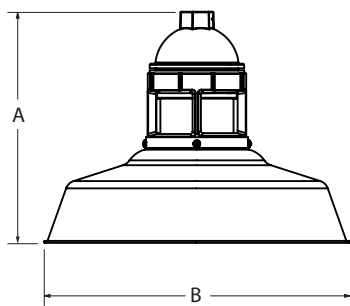

SHADE CODE	HEIGHT (A)	DIAMETER (B)
ULS12	9.9"	12"
ULS14	10.6"	14"
ULS16	11.2"	16"
ULS18	11.9"	18"

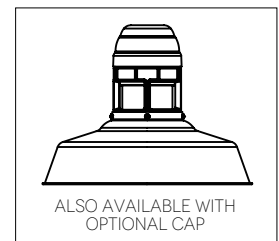

**LIGHT SOURCE**

All published luminaire photometric testing performed to IESNA LM-79-08 standards by a NVLAP accredited laboratory. Data is considered to be representative of the configurations shown, within the tolerances allowed by Lighting Facts. To obtain an IES file specific to your project, please contact the factory.

OPTION	WATTAGE	LUMENS <small>*Avg. value, actual value dependent on bulb used</small>	CRI	VOLTAGE	DIMMING
<b>INCANDESCENT (MED E26)</b>					
<b>E26</b>	100W Max	1400*	100	120 VAC	Bulb Dependant
<b>COMPACT FLOURESCENT (GU24 CFL)</b>					
<b>GU24</b>	18W Max	1400*	75	120 VAC	Bulb Dependant
<b>LED</b>					
<b>LED16.8</b>	16.8W	1600	>90	120 VAC	TRIAC

**SPECIFICATIONS**

**MOUNTING**

**STEM**  
1/2" Nominal (0.84" Actual) or 3/4" Nominal (1.05" Actual) Sch 40, 6063 Aluminum Mounting Stem. Custom Lengths Available upon Request.

**GOOSENECK**  
1/2" Nominal (0.84" Actual) or 3/4" Nominal (1.05" Actual) Sch 40, 6063 Aluminum Gooseneck

**CORD**  
Cord-hung Pendants Include 7' Of Standard Cord Or 5' Of Cotton Cord, +/- For Socket Orientation

**SHADE & FINISHES**

**SYDNEY SHADE**  
Hand-Spun from High Purity 0.050" Thick 3003-O Temper Aluminum

**POWDER COAT FINISHES**  
Polyester Powder Coat Finishes Are Electro-Statically Applied and Thermocured

**CERTIFICATIONS, LISTINGS & WARRANTY**

**MADE IN THE USA**  
Manufactured and Hand-Crafted in Our 60,000 Square Foot Facility Located in Titusville, FL

**CSA LISTED FOR WET LOCATIONS**  
Includes all Stem and Gooseneck Mounting Styles

**CSA LISTED FOR DAMP LOCATIONS**  
Includes all Chain and Select Cord Hung Mounting Styles

**LIMITED WARRANTY**  
For Additional Information on Our Limited Warranty, Please See Our Terms & Conditions

**LED SPECIFICATIONS**

**LUMEN MAINTENANCE**  
LED16.8 Source is L90(11K) > 61,000 Hours.

**COLOR TEMPERATURES**  
Standard Color Temperatures Available Include 2700K, 3000K, 3500K and 4000K. Custom Temperatures Available upon Request.

**CRI**  
Minimum 90 CRI. Consult Factory for Other CRI Options.

**EFFICACY**  
Delivers over 95 Lumens Per Watt

**DRIVER & DIMMING OPTION**  
Reliant on Triac Dimming 16.8W / 120V, Dimmable down to 1% Depending on Dimmer. Requires Compatible Dimming Switch.